

GIA NATURAL COLORED DIAMOND REPORT

May 28, 2021
 Report Type Grading Report
 GIA Report Number 2215666333
 Shape and Cutting Style Pear Modified Brilliant
 Measurements 6.26 x 3.52 x 2.22 mm

Carat Weight 0.29 carat
 Color Grade Fancy Intense Blue
 Color Origin Natural
 Color Distribution Even
 Clarity Grade SI2
 Proportions:

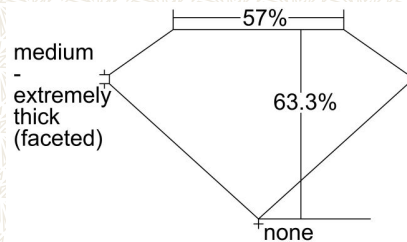

Profile not to actual proportions

Polish Good
 Symmetry Good
 Fluorescence None
 Inscription(s): GIA 2215666333

ADDITIONAL INFORMATION

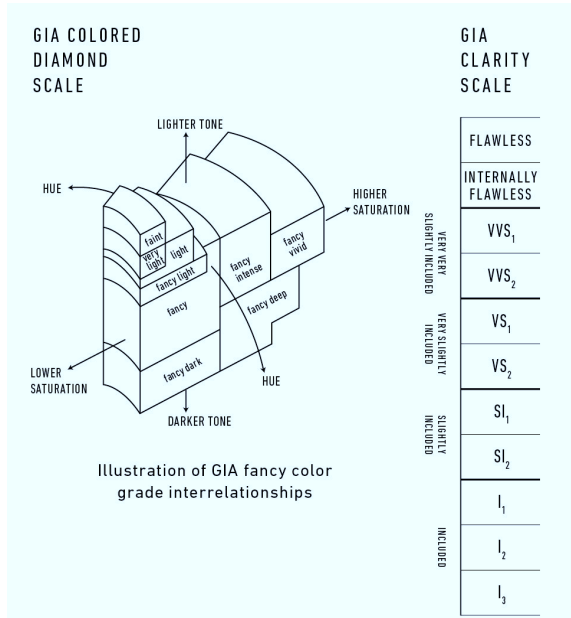

CLARITY CHARACTERISTICS

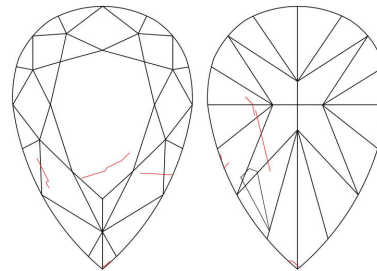

KEY TO SYMBOLS*

-  Feather
-  Chip
-  Extra Facet

* Red symbols denote internal characteristics (inclusions). Green or black symbols denote external characteristics (blemishes). Diagram is an approximate representation of the diamond, and symbols shown indicate type, position, and approximate size of clarity characteristics. All clarity characteristics may not be shown. Details of finish are not shown.



reportcheck.gia.edu



The results documented in this report refer only to the diamond described, and were obtained using the techniques and equipment available to GIA at the time of examination. This report is not a guarantee or valuation. For additional information and important limitations and disclaimers, please see GIA.edu/terms or call +1 800 421 7250 or +1 760 603 4500. ©2017 Gemological Institute of America, Inc.

 THE SECURITY FEATURES IN THIS DOCUMENT, INCLUDING THE HOLOGRAM, SECURITY SCREEN AND MICROPRINT LINES, IN ADDITION TO THOSE NOT LISTED, EXCEED DOCUMENT SECURITY INDUSTRY GUIDELINES.

GIA NATURAL COLORED DIAMOND REPORT

May 28, 2021
 Report Type Grading Report
 GIA Report Number 2211666292
 Shape and Cutting Style Pear Modified Brilliant
 Measurements 5.95 x 3.73 x 2.39 mm

Carat Weight 0.34 carat
 Color Grade Fancy Intense Blue
 Color Origin Natural
 Color Distribution Even
 Clarity Grade SI2
 Proportions:

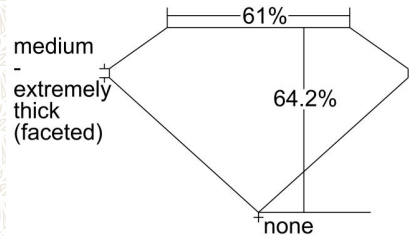

Profile not to actual proportions

Polish Good
 Symmetry Good
 Fluorescence None
 Inscription(s): GIA 2211666292

ADDITIONAL INFORMATION

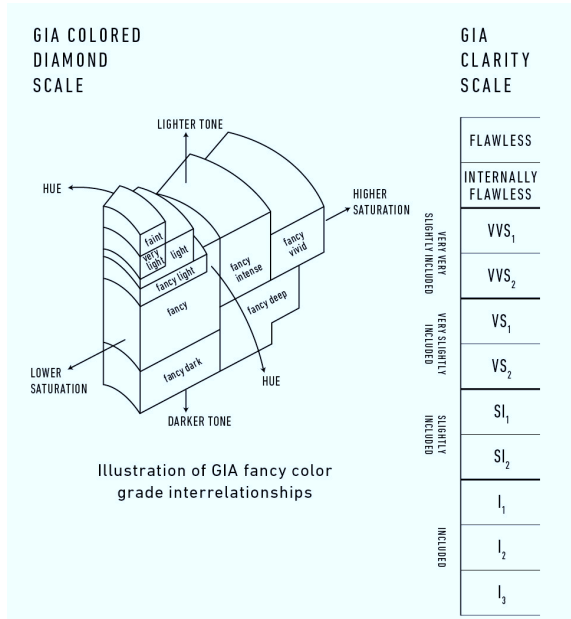

CLARITY CHARACTERISTICS

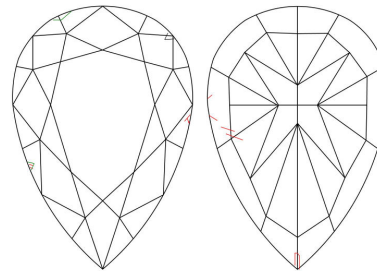

KEY TO SYMBOLS*

- Feather
- Chip
- Cavity
- Natural
- Extra Facet

* Red symbols denote internal characteristics (inclusions). Green or black symbols denote external characteristics (blemishes). Diagram is an approximate representation of the diamond, and symbols shown indicate type, position, and approximate size of clarity characteristics. All clarity characteristics may not be shown. Details of finish are not shown.



reportcheck.gia.edu



The results documented in this report refer only to the diamond described, and were obtained using the techniques and equipment available to GIA at the time of examination. This report is not a guarantee or valuation. For additional information and important limitations and disclaimers, please see GIA.edu/terms or call +1 800 421 7250 or +1 760 603 4500. ©2017 Gemological Institute of America, Inc.

 THE SECURITY FEATURES IN THIS DOCUMENT, INCLUDING THE HOLOGRAM, SECURITY SCREEN AND MICROPRINT LINES, IN ADDITION TO THOSE NOT LISTED, EXCEED DOCUMENT SECURITY INDUSTRY GUIDELINES.

GIA NATURAL COLORED DIAMOND REPORT

October 18, 2022
 Report Type Grading Report
 GIA Report Number 2171995821
 Shape and Cutting Style Cut-Cornered Rectangular
 Modified Brilliant
 Measurements 8.26 x 7.83 x 5.05 mm

 Carat Weight 3.16 carat
 Color Grade Fancy Vivid Green-Yellow
 Color Origin Natural
 Color Distribution Even
 Clarity Grade SI1
 Proportions:

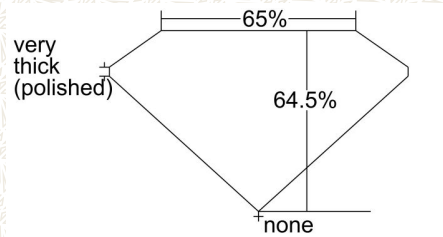

Profile not to actual proportions

Polish Very Good
 Symmetry Very Good
 Fluorescence Very Strong Yellow
 Inscription(s): GIA 2171995821

Comments: Additional clouds are not shown. Pinpoints are not shown.

ADDITIONAL INFORMATION

GIA COLORED DIAMOND SCALE

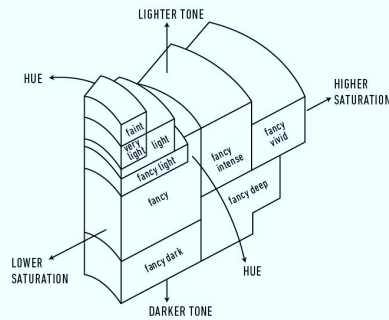
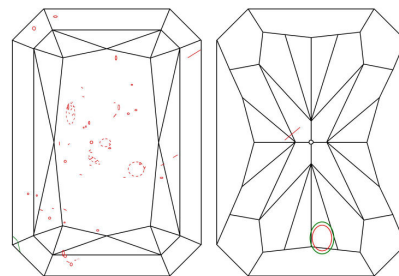

Illustration of GIA fancy color grade interrelationships

GIA CLARITY SCALE

FLAWLESS
INTERNALLY FLAWLESS
VVS ₁
VVS ₂
VS ₁
VS ₂
SI ₁
SI ₂
I ₁
I ₂
I ₃

CLARITY CHARACTERISTICS



KEY TO SYMBOLS*

- Crystal
- \ Needle
- ~ Feather
- ^ Natural
- ⊖ Knot
- ⊙ Cloud

* Red symbols denote internal characteristics (inclusions). Green or black symbols denote external characteristics (blemishes). Diagram is an approximate representation of the diamond, and symbols shown indicate type, position, and approximate size of clarity characteristics. All clarity characteristics may not be shown. Details of finish are not shown.



reportcheck.gia.edu



The results documented in this report refer only to the diamond described, and were obtained using the techniques and equipment available to GIA at the time of examination. This report is not a guarantee or valuation. For additional information and important limitations and disclaimers, please see GIA.edu/terms or call +1 800 421 7250 or +1 760 603 4500. ©2022 Gemological Institute of America, Inc.

 THE SECURITY FEATURES IN THIS DOCUMENT, INCLUDING THE HOLOGRAM, SECURITY SCREEN AND MICROPRINT LINES, IN ADDITION TO THOSE NOT LISTED, EXCEED DOCUMENT SECURITY INDUSTRY GUIDELINES.