

Verify this report at GIA.edu

GIA NATURAL COLORED DIAMOND REPORT

December 28, 2023
 Report Type Identification and Origin Report
 GIA Report Number 1236153056
 Shape and Cutting Style .Cut-Cornered Square Modified
 Brilliant
 Measurements 3.23 x 3.20 x 2.09 mm
 Carat Weight 0.19 carat
 Color Grade Fancy Pink-Purple
 Color Origin Natural
 Color Distribution Even
 Inscription(s): GIA 1236153056

ADDITIONAL INFORMATION

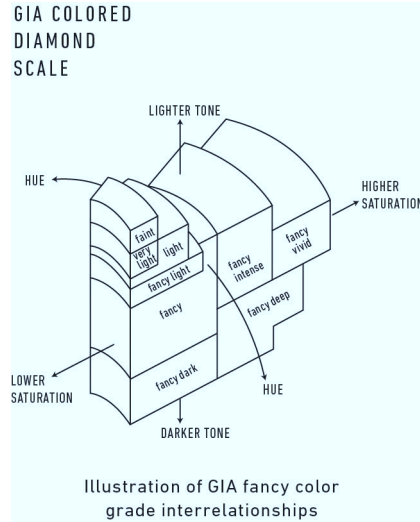

The results documented in this report refer only to the diamond described, and were obtained using the techniques and equipment available to GIA at the time of examination. This report is not a guarantee or valuation. For additional information and important limitations and disclaimers, please see GIA.edu/terms or call +1 800 421 7250 or +1 760 603 4500. ©2023 Gemological Institute of America, Inc.

reportcheck.gia.edu



GIA NATURAL COLORED DIAMOND REPORT

December 28, 2023
 Report Type Identification and Origin Report
 GIA Report Number 5231153048
 Shape and Cutting Style .Cut-Cornered Square Modified
 Brilliant
 Measurements 3.46 x 3.45 x 2.11 mm
 Carat Weight 0.22 carat
 Color Grade Fancy Pink
 Color Origin Natural
 Color Distribution Even
 Inscription(s): GIA 5231153048

ADDITIONAL INFORMATION

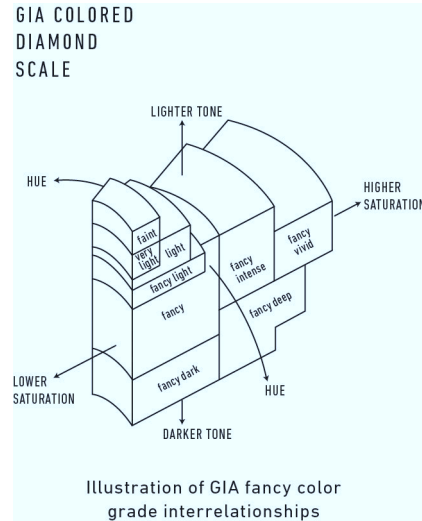

The results documented in this report refer only to the diamond described, and were obtained using the techniques and equipment available to GIA at the time of examination. This report is not a guarantee or valuation. For additional information and important limitations and disclaimers, please see GIA.edu/terms or call +1 800 421 7250 or +1 760 603 4500. ©2023 Gemological Institute of America, Inc.

reportcheck.gia.edu



Verify this report at GIA.edu

GIA NATURAL COLORED DIAMOND REPORT

December 28, 2023
 Report Type Identification and Origin Report
 GIA Report Number 1236153049
 Shape and Cutting Style .Cut-Cornered Square Modified
 Brilliant
 Measurements 3.46 x 3.42 x 2.13 mm
 Carat Weight 0.22 carat
 Color Grade Fancy Purplish Pink
 Color Origin Natural
 Color Distribution Even
 Inscription(s): GIA 1236153049

ADDITIONAL INFORMATION

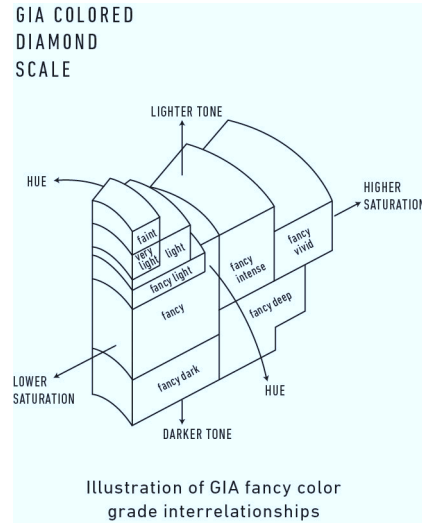

The results documented in this report refer only to the diamond described, and were obtained using the techniques and equipment available to GIA at the time of examination. This report is not a guarantee or valuation. For additional information and important limitations and disclaimers, please see GIA.edu/terms or call +1 800 421 7250 or +1 760 603 4500. ©2023 Gemological Institute of America, Inc.

reportcheck.gia.edu



Verify this report at GIA.edu

GIA NATURAL COLORED DIAMOND REPORT

December 28, 2023
 Report Type Identification and Origin Report
 GIA Report Number 1236153059
 Shape and Cutting Style .Cut-Cornered Square Modified
 Brilliant
 Measurements 3.52 x 3.48 x 2.15 mm
 Carat Weight 0.23 carat
 Color Grade Fancy Pink
 Color Origin Natural
 Color Distribution Even
 Inscription(s): GIA 1236153059

ADDITIONAL INFORMATION

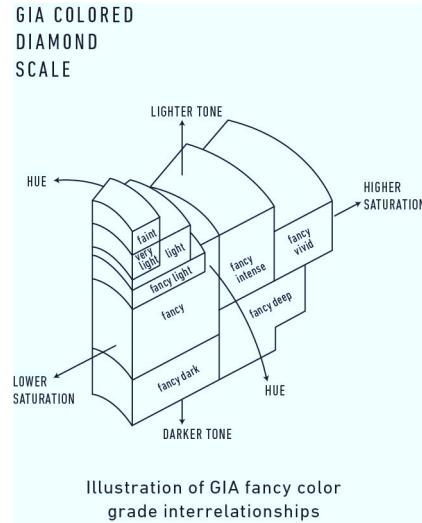

The results documented in this report refer only to the diamond described, and were obtained using the techniques and equipment available to GIA at the time of examination. This report is not a guarantee or valuation. For additional information and important limitations and disclaimers, please see GIA.edu/terms or call +1 800 421 7250 or +1 760 603 4500. ©2023 Gemological Institute of America, Inc.

reportcheck.gia.edu



Verify this report at GIA.edu

GIA NATURAL COLORED DIAMOND REPORT

December 28, 2023
 Report Type **Identification and Origin Report**
 GIA Report Number **1236153064**
 Shape and Cutting Style **.Cut-Cornered Square Modified Brilliant**
 Measurements **3.61 x 3.56 x 2.07 mm**
 Carat Weight **0.23 carat**
 Color Grade **Fancy Purplish Pink**
 Color Origin **Natural**
 Color Distribution **Even**
 Inscription(s): **GIA 1236153064**

ADDITIONAL INFORMATION

GIA COLORED DIAMOND SCALE

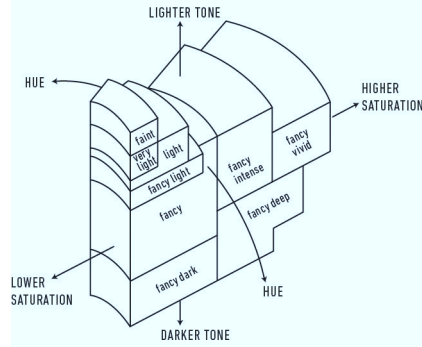

Illustration of GIA fancy color grade interrelationships



The results documented in this report refer only to the diamond described, and were obtained using the techniques and equipment available to GIA at the time of examination. This report is not a guarantee or valuation. For additional information and important limitations and disclaimers, please see GIA.edu/terms or call +1 800 421 7250 or +1 760 603 4500.
 ©2023 Gemological Institute of America, Inc.

reportcheck.gia.edu



GIA NATURAL COLORED DIAMOND REPORT

December 28, 2023
 Report Type Identification and Origin Report
 GIA Report Number 6234153053
 Shape and Cutting Style .Cut-Cornered Square Modified
 Brilliant
 Measurements 3.60 x 3.51 x 2.13 mm
 Carat Weight 0.23 carat
 Color Grade Fancy Brownish Pink
 Color Origin Natural
 Color Distribution Even
 Inscription(s): GIA 6234153053

ADDITIONAL INFORMATION

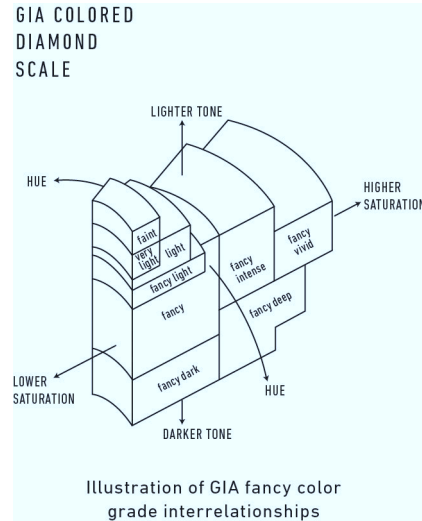

The results documented in this report refer only to the diamond described, and were obtained using the techniques and equipment available to GIA at the time of examination. This report is not a guarantee or valuation. For additional information and important limitations and disclaimers, please see GIA.edu/terms or call +1 800 421 7250 or +1 760 603 4500. ©2023 Gemological Institute of America, Inc.

reportcheck.gia.edu



Verify this report at GIA.edu

GIA NATURAL COLORED DIAMOND REPORT

December 28, 2023
 Report Type Identification and Origin Report
 GIA Report Number 6234153044
 Shape and Cutting Style .Cut-Cornered Square Modified
 Brilliant
 Measurements 3.62 x 3.61 x 2.10 mm
 Carat Weight 0.24 carat
 Color Grade Fancy Pink
 Color Origin Natural
 Color Distribution Even
 Inscription(s): GIA 6234153044

ADDITIONAL INFORMATION

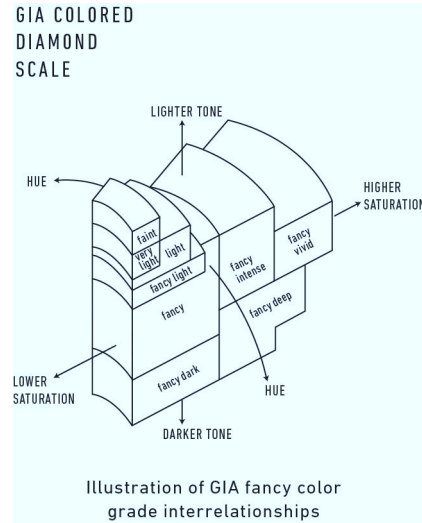

The results documented in this report refer only to the diamond described, and were obtained using the techniques and equipment available to GIA at the time of examination. This report is not a guarantee or valuation. For additional information and important limitations and disclaimers, please see GIA.edu/terms or call +1 800 421 7250 or +1 760 603 4500. ©2023 Gemological Institute of America, Inc.

reportcheck.gia.edu



Verify this report at GIA.edu

GIA NATURAL COLORED DIAMOND REPORT

December 28, 2023
 Report Type Identification and Origin Report
 GIA Report Number 6234153063
 Shape and Cutting Style .Cut-Cornered Square Modified
 Brilliant
 Measurements 3.92 x 3.82 x 2.03 mm
 Carat Weight 0.24 carat
 Color Grade Fancy Pink
 Color Origin Natural
 Color Distribution Even
 Inscription(s): GIA 6234153063

ADDITIONAL INFORMATION

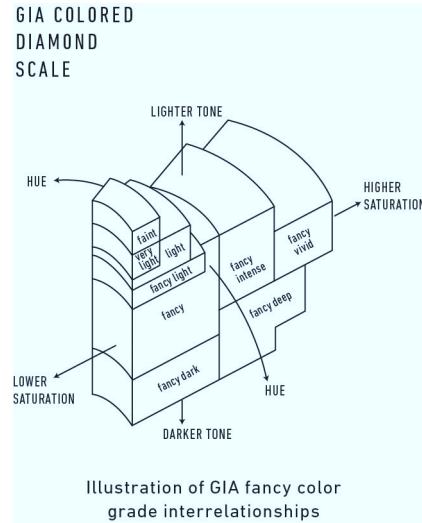

The results documented in this report refer only to the diamond described, and were obtained using the techniques and equipment available to GIA at the time of examination. This report is not a guarantee or valuation. For additional information and important limitations and disclaimers, please see GIA.edu/terms or call +1 800 421 7250 or +1 760 603 4500. ©2023 Gemological Institute of America, Inc.

reportcheck.gia.edu



GIA NATURAL COLORED DIAMOND REPORT

December 28, 2023
 Report Type Identification and Origin Report
 GIA Report Number 5231153045
 Shape and Cutting Style .Cut-Cornered Square Modified
 Brilliant
 Measurements 3.58 x 3.54 x 2.17 mm
 Carat Weight 0.25 carat
 Color Grade Fancy Purplish Pink
 Color Origin Natural
 Color Distribution Even
 Inscription(s): GIA 5231153045

ADDITIONAL INFORMATION



The results documented in this report refer only to the diamond described, and were obtained using the techniques and equipment available to GIA at the time of examination. This report is not a guarantee or valuation. For additional information and important limitations and disclaimers, please see GIA.edu/terms or call +1 800 421 7250 or +1 760 603 4500. ©2023 Gemological Institute of America, Inc.

reportcheck.gia.edu



Verify this report at GIA.edu

GIA NATURAL COLORED DIAMOND REPORT

December 28, 2023
 Report Type Identification and Origin Report
 GIA Report Number 2235153052
 Shape and Cutting Style .Cut-Cornered Square Modified
 Brilliant
 Measurements 3.56 x 3.53 x 2.23 mm
 Carat Weight 0.25 carat
 Color Grade Fancy Pink
 Color Origin Natural
 Color Distribution Even
 Inscription(s): GIA 2235153052

ADDITIONAL INFORMATION

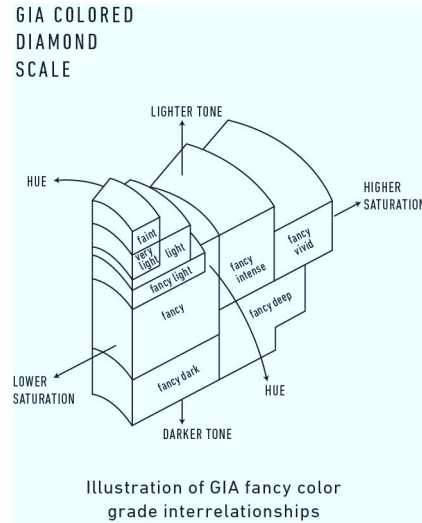

The results documented in this report refer only to the diamond described, and were obtained using the techniques and equipment available to GIA at the time of examination. This report is not a guarantee or valuation. For additional information and important limitations and disclaimers, please see GIA.edu/terms or call +1 800 421 7250 or +1 760 603 4500. ©2023 Gemological Institute of America, Inc.

reportcheck.gia.edu



 THE SECURITY FEATURES IN THIS DOCUMENT, INCLUDING THE HOLOGRAM, SECURITY SCREEN AND MICROPRINT LINES, IN ADDITION TO THOSE NOT LISTED, EXCEED DOCUMENT SECURITY INDUSTRY GUIDELINES.

Verify this report at GIA.edu

GIA NATURAL COLORED DIAMOND REPORT

December 28, 2023
 Report Type **Identification and Origin Report**
 GIA Report Number **5234153058**
 Shape and Cutting Style **.Cut-Cornered Square Modified Brilliant**
 Measurements **3.76 x 3.72 x 2.20 mm**
 Carat Weight **0.27 carat**
 Color Grade **Fancy Brownish Pink**
 Color Origin **Natural**
 Color Distribution **Even**
 Inscription(s): **GIA 5234153058**

ADDITIONAL INFORMATION

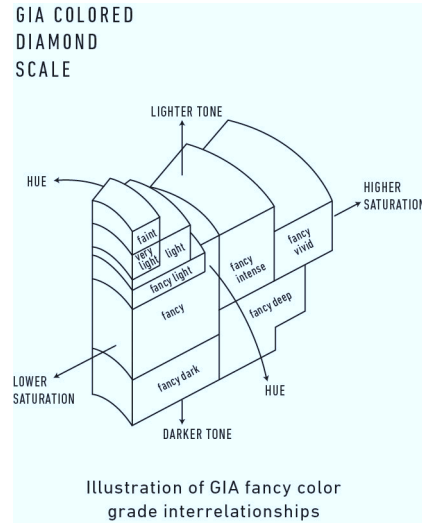

The results documented in this report refer only to the diamond described, and were obtained using the techniques and equipment available to GIA at the time of examination. This report is not a guarantee or valuation. For additional information and important limitations and disclaimers, please see GIA.edu/terms or call +1 800 421 7250 or +1 760 603 4500. ©2023 Gemological Institute of America, Inc.

reportcheck.gia.edu



 THE SECURITY FEATURES IN THIS DOCUMENT, INCLUDING THE HOLOGRAM, SECURITY SCREEN AND MICROPRINT LINES, IN ADDITION TO THOSE NOT LISTED, EXCEED DOCUMENT SECURITY INDUSTRY GUIDELINES.

Verify this report at GIA.edu

GIA NATURAL COLORED DIAMOND REPORT

December 28, 2023
 Report Type **Identification and Origin Report**
 GIA Report Number **2235153066**
 Shape and Cutting Style **.Cut-Cornered Square Modified Brilliant**
 Measurements **3.65 x 3.63 x 2.27 mm**
 Carat Weight **0.27 carat**
 Color Grade **Fancy Brownish Pink**
 Color Origin **Natural**
 Color Distribution **Even**
 Inscription(s): **GIA 2235153066**

ADDITIONAL INFORMATION

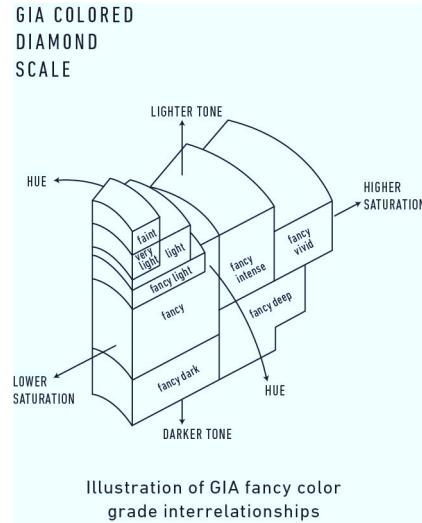

The results documented in this report refer only to the diamond described, and were obtained using the techniques and equipment available to GIA at the time of examination. This report is not a guarantee or valuation. For additional information and important limitations and disclaimers, please see GIA.edu/terms or call +1 800 421 7250 or +1 760 603 4500. ©2023 Gemological Institute of America, Inc.

reportcheck.gia.edu



Verify this report at GIA.edu

GIA NATURAL COLORED DIAMOND REPORT

December 28, 2023
 Report Type **Identification and Origin Report**
 GIA Report Number **2231153104**
 Shape and Cutting Style **.Cut-Cornered Square Modified Brilliant**
 Measurements **3.82 x 3.78 x 2.27 mm**
 Carat Weight **0.28 carat**
 Color Grade **Fancy Pink**
 Color Origin **Natural**
 Color Distribution **Even**
 Inscription(s): **GIA 2231153104**

ADDITIONAL INFORMATION

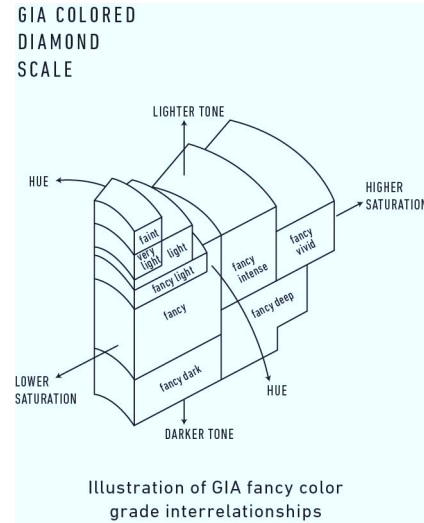

reportcheck.gia.edu



The results documented in this report refer only to the diamond described, and were obtained using the techniques and equipment available to GIA at the time of examination. This report is not a guarantee or valuation. For additional information and important limitations and disclaimers, please see GIA.edu/terms or call +1 800 421 7250 or +1 760 603 4500. ©2023 Gemological Institute of America, Inc.

 THE SECURITY FEATURES IN THIS DOCUMENT, INCLUDING THE HOLOGRAM, SECURITY SCREEN AND MICROPRINT LINES, IN ADDITION TO THOSE NOT LISTED, EXCEED DOCUMENT SECURITY INDUSTRY GUIDELINES.

Verify this report at GIA.edu

GIA NATURAL COLORED DIAMOND REPORT

December 28, 2023
 Report Type Identification and Origin Report
 GIA Report Number 5231153101
 Shape and Cutting Style .Cut-Cornered Square Modified
 Brilliant
 Measurements 4.07 x 3.99 x 2.22 mm
 Carat Weight 0.31 carat
 Color Grade Fancy Pink-Purple
 Color Origin Natural
 Color Distribution Even
 Inscription(s): GIA 5231153101

ADDITIONAL INFORMATION

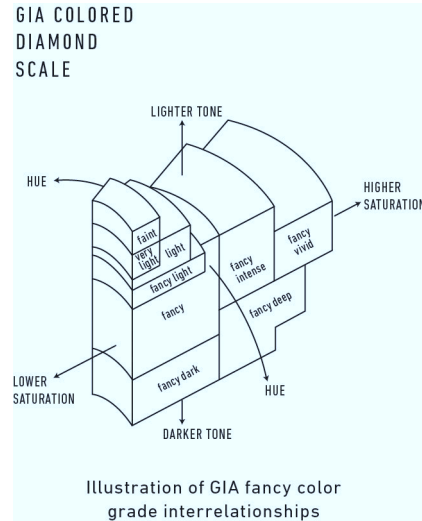

The results documented in this report refer only to the diamond described, and were obtained using the techniques and equipment available to GIA at the time of examination. This report is not a guarantee or valuation. For additional information and important limitations and disclaimers, please see GIA.edu/terms or call +1 800 421 7250 or +1 760 603 4500. ©2023 Gemological Institute of America, Inc.

reportcheck.gia.edu



Verify this report at GIA.edu

GIA NATURAL COLORED DIAMOND REPORT

December 28, 2023
 Report Type Identification and Origin Report
 GIA Report Number 2239153046
 Shape and Cutting Style .Cut-Cornered Square Modified
 Brilliant
 Measurements 4.05 x 4.05 x 2.32 mm
 Carat Weight 0.33 carat
 Color Grade Fancy Light Orangy Pink
 Color Origin Natural
 Color Distribution Even
 Inscription(s): GIA 2239153046

ADDITIONAL INFORMATION

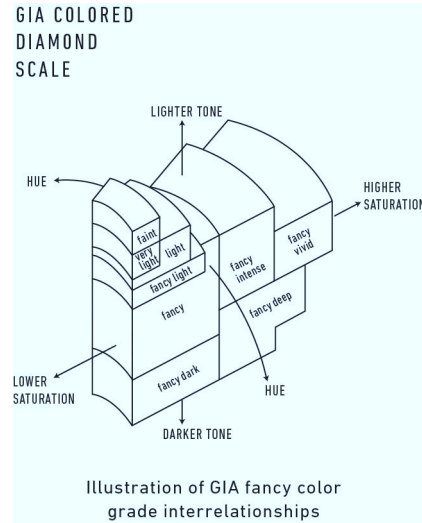

The results documented in this report refer only to the diamond described, and were obtained using the techniques and equipment available to GIA at the time of examination. This report is not a guarantee or valuation. For additional information and important limitations and disclaimers, please see GIA.edu/terms or call +1 800 421 7250 or +1 760 603 4500. ©2023 Gemological Institute of America, Inc.

reportcheck.gia.edu



Verify this report at GIA.edu

GIA NATURAL COLORED DIAMOND REPORT

December 28, 2023
 Report Type Identification and Origin Report
 GIA Report Number 5234153055
 Shape and Cutting Style .Cut-Cornered Square Modified
 Brilliant
 Measurements 3.80 x 3.73 x 2.47 mm
 Carat Weight 0.34 carat
 Color Grade Fancy Pink-Purple
 Color Origin Natural
 Color Distribution Even
 Inscription(s): GIA 5234153055

ADDITIONAL INFORMATION

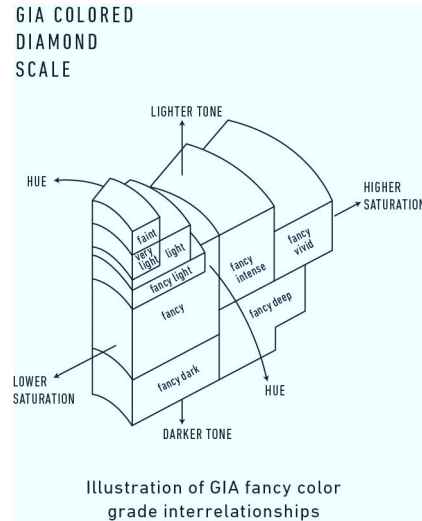

The results documented in this report refer only to the diamond described, and were obtained using the techniques and equipment available to GIA at the time of examination. This report is not a guarantee or valuation. For additional information and important limitations and disclaimers, please see GIA.edu/terms or call +1 800 421 7250 or +1 760 603 4500. ©2023 Gemological Institute of America, Inc.

reportcheck.gia.edu



GIA NATURAL COLORED DIAMOND REPORT

December 28, 2023
 Report Type Identification and Origin Report
 GIA Report Number 2231153060
 Shape and Cutting Style .Cut-Cornered Square Modified
 Brilliant
 Measurements 3.78 x 3.74 x 2.50 mm
 Carat Weight 0.34 carat
 Color Grade Fancy Purple-Pink
 Color Origin Natural
 Color Distribution Even
 Inscription(s): GIA 2231153060

ADDITIONAL INFORMATION



The results documented in this report refer only to the diamond described, and were obtained using the techniques and equipment available to GIA at the time of examination. This report is not a guarantee or valuation. For additional information and important limitations and disclaimers, please see GIA.edu/terms or call +1 800 421 7250 or +1 760 603 4500. ©2023 Gemological Institute of America, Inc.

reportcheck.gia.edu



 THE SECURITY FEATURES IN THIS DOCUMENT, INCLUDING THE HOLOGRAM, SECURITY SCREEN AND MICROPRINT LINES, IN ADDITION TO THOSE NOT LISTED, EXCEED DOCUMENT SECURITY INDUSTRY GUIDELINES.

Verify this report at GIA.edu

GIA NATURAL COLORED DIAMOND REPORT

December 28, 2023
 Report TypeIdentification and Origin Report
 GIA Report Number 2235153068
 Shape and Cutting Style .Cut-Cornered Square Modified
 Brilliant
 Measurements 3.97 x 3.97 x 2.48 mm
 Carat Weight 0.36 carat
 Color Grade Fancy Pink-Purple
 Color Origin Natural
 Color Distribution Even
 Inscription(s): GIA 2235153068

ADDITIONAL INFORMATION

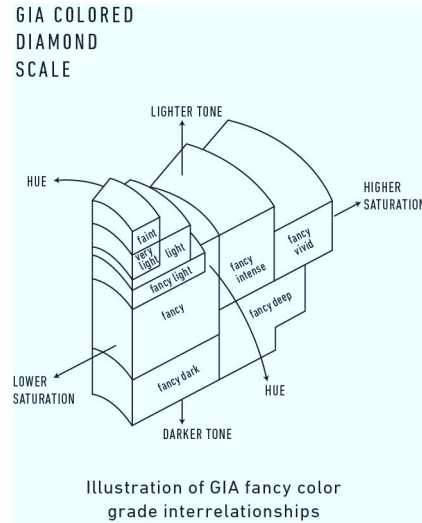

The results documented in this report refer only to the diamond described, and were obtained using the techniques and equipment available to GIA at the time of examination. This report is not a guarantee or valuation. For additional information and important limitations and disclaimers, please see GIA.edu/terms or call +1 800 421 7250 or +1 760 603 4500. ©2023 Gemological Institute of America, Inc.

reportcheck.gia.edu



Verify this report at GIA.edu

GIA NATURAL COLORED DIAMOND REPORT

December 28, 2023
 Report Type **Identification and Origin Report**
 GIA Report Number **2231153037**
 Shape and Cutting Style **.Cut-Cornered Square Modified Brilliant**
 Measurements **4.27 x 4.22 x 2.60 mm**
 Carat Weight **0.42 carat**
 Color Grade **Fancy Brownish Pink**
 Color Origin **Natural**
 Color Distribution **Even**
 Inscription(s): **GIA 2231153037**

ADDITIONAL INFORMATION

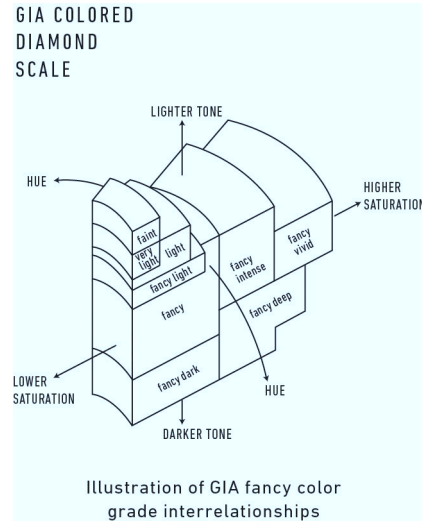

The results documented in this report refer only to the diamond described, and were obtained using the techniques and equipment available to GIA at the time of examination. This report is not a guarantee or valuation. For additional information and important limitations and disclaimers, please see GIA.edu/terms or call +1 800 421 7250 or +1 760 603 4500. ©2023 Gemological Institute of America, Inc.

reportcheck.gia.edu



 THE SECURITY FEATURES IN THIS DOCUMENT, INCLUDING THE HOLOGRAM, SECURITY SCREEN AND MICROPRINT LINES, IN ADDITION TO THOSE NOT LISTED, EXCEED DOCUMENT SECURITY INDUSTRY GUIDELINES.

Verify this report at GIA.edu

GIA NATURAL COLORED DIAMOND REPORT

December 28, 2023
 Report Type **Identification and Origin Report**
 GIA Report Number **2235153067**
 Shape and Cutting Style **.Cut-Cornered Square Modified Brilliant**
 Measurements **4.34 x 4.30 x 2.74 mm**
 Carat Weight **0.47 carat**
 Color Grade **Fancy Purplish Pink**
 Color Origin **Natural**
 Color Distribution **Even**
 Inscription(s): **GIA 2235153067**

ADDITIONAL INFORMATION

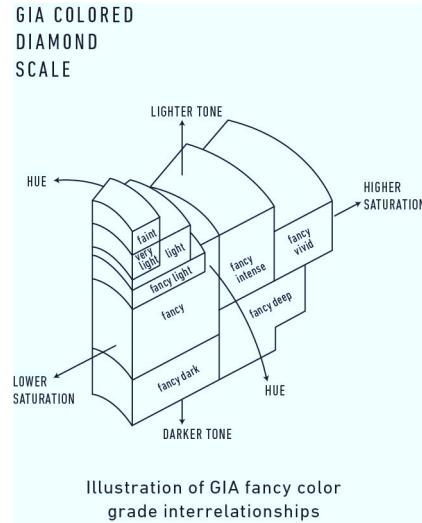

The results documented in this report refer only to the diamond described, and were obtained using the techniques and equipment available to GIA at the time of examination. This report is not a guarantee or valuation. For additional information and important limitations and disclaimers, please see GIA.edu/terms or call +1 800 421 7250 or +1 760 603 4500. ©2023 Gemological Institute of America, Inc.

reportcheck.gia.edu



Verify this report at GIA.edu

GIA NATURAL COLORED DIAMOND REPORT

December 28, 2023
 Report Type Identification and Origin Report
 GIA Report Number 5234153042
 Shape and Cutting Style .Cut-Cornered Square Modified
 Brilliant
 Measurements 4.30 x 4.21 x 2.83 mm
 Carat Weight 0.49 carat
 Color Grade Fancy Brownish Purplish Pink
 Color Origin Natural
 Color Distribution Even
 Inscription(s): GIA 5234153042

ADDITIONAL INFORMATION

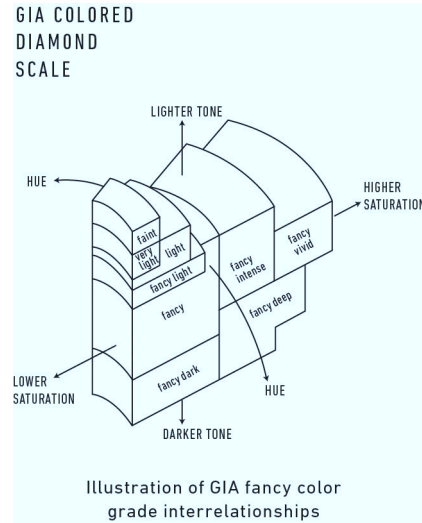

The results documented in this report refer only to the diamond described, and were obtained using the techniques and equipment available to GIA at the time of examination. This report is not a guarantee or valuation. For additional information and important limitations and disclaimers, please see GIA.edu/terms or call +1 800 421 7250 or +1 760 603 4500. ©2023 Gemological Institute of America, Inc.

reportcheck.gia.edu



Verify this report at GIA.edu

GIA NATURAL COLORED DIAMOND REPORT

December 28, 2023
 Report Type Identification and Origin Report
 GIA Report Number 6234153038
 Shape and Cutting Style .Cut-Cornered Square Modified
 Brilliant
 Measurements 4.59 x 4.46 x 2.75 mm
 Carat Weight 0.51 carat
 Color Grade Fancy Purple-Pink
 Color Origin Natural
 Color Distribution Even
 Inscription(s): GIA 6234153038

ADDITIONAL INFORMATION

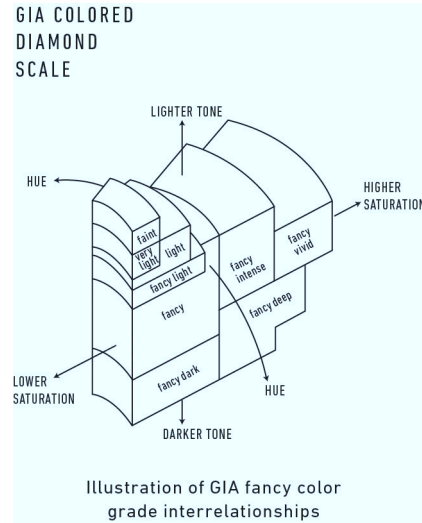

The results documented in this report refer only to the diamond described, and were obtained using the techniques and equipment available to GIA at the time of examination. This report is not a guarantee or valuation. For additional information and important limitations and disclaimers, please see GIA.edu/terms or call +1 800 421 7250 or +1 760 603 4500. ©2023 Gemological Institute of America, Inc.

reportcheck.gia.edu

